

合格证
QC PASS



Wechat
Official Account
神牛微信公众号

深圳市神牛摄影器材有限公司

地址: 深圳市宝安区福海街道塘尾社区耀川工业区厂房2栋
电话: 0755-29609320(8062) 传真: 0755-25723423 邮箱: godox@godox.com

GODOX Photo Equipment Co., Ltd.

Add.: Building 2, Yaochuan Industrial Zone, Tangwei Community, Fuhai Street, Bao'an District, Shenzhen 518103, China Tel: +86-755-29609320(8062) Fax: +86-755-25723423
E-mail: godox@godox.com

www.godox.com

Made in China | 705-C7R000-01



Godox

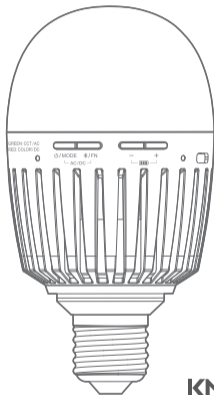

KNOWLED C7R

RGBWW 影视创意灯泡
KNOWLED RGBWW Creative Bulb

使用手册
Instruction Manual

Safety Instructions and Attentions

First of all, as the most basic principle: This product is a professional lighting set equipment and should be used by professional lighting engineers or under the guidance of professionals. Basic safety attentions must always be followed during use, as follows:

1. Before use, please read and understand these instructions and attentions.
2. Professional lighting is prohibited for children. When children are near, parents or accompanying persons must supervise closely to prevent children from personal injury due to collision with lamps or private use of lamps.
3. This lighting product is not ordinary lighting product and cannot be used for general lighting. Anyone who has suffered eye damage or has sensitive eyes should avoid using this product.
4. When the lamp is on, it must be used with care. Do not touch high-temperature parts, such as LED lamp beads, to avoid burns.
5. When the lamp is on, it is forbidden to look directly at the lamp beads under any circumstances. Strong light should be used under the guidance of professional lighting engineers. Avoid prolonged exposure to strong light under any circumstances. If eye discomfort, please turn off the lamp in time, suspend use, and see a doctor immediately.
6. If the lamp bead is damaged or deformed by heat, stop using this equipment, and contact the manufacturer, service agent or qualified maintenance personnel to replace the lamp bead in time to avoid accidents.
7. This product is only suitable for use in -10°C to +40°C operating environment and normal humidity environment.
8. Do not use damaged equipment or accessories, and wait for professional maintenance personnel to check and repair to confirm being normal before use.
9. During using, if the casing of this product is broken due to being dropped, squeezed or subjected to strong impact, please do not use it, so as to avoid electric shock injury due to contact with internal electronic components.
10. If an extension cord is required, please use an extension cord with a current rating greater than or equal to that of the equipment. If an extension cord is rated less than the equipment, overheating may result.
11. Some products have long power cords, please place the power cords properly and keep them in a safe place. Avoid contacting the power cord with overheating surfaces, avoid improper placement that could cause pulling damage, or trip on-site personnel. Please use the certified power cord from the original manufacturer. If the product is damaged by using a non-certified power cord, it will not be repaired by our factory.
12. Be sure to unplug equipment from the power outlet before cleaning and repairing. When not in use,

do not pull the power cord to unplug the equipment. For normal power-off, please hold both ends of the plug of the equipment with your hands and pull the plug out of power outlet. This equipment needs to be connected to a grounded outlet.

13. This equipment is not waterproof, please keep it dry and do not immerse it in water or other liquids. The equipment should be installed in a dry and ventilated place, and avoid using it in rainy, humid, dusty or overheated environments. Do not place any objects on the lamp or let liquid flow into the lamp to avoid accidents.
14. Do not disassemble the product without permission. If the product fails, it must be checked and repaired by authorized maintenance personnel.
15. Before storing, make sure that the equipment has cooled down completely. For storage, unplug the power cord from the equipment. The equipment should be placed in the carrying case or in a ventilated dry place.
16. Do not place equipment near flammable and volatile solvents such as alcohol and gasoline.
17. Do not use accessories that are not recommended by our factory to avoid fire, electric shock or personal injury.
18. When cleaning, do not wipe it with a damp cloth, please use a dry cloth or a soft cloth to wipe the dirt of the equipment.
19. Please take off the protective cover before using.
20. This product complies with ROHS and CE certification, please refer to the relevant national standards for use and operation.
21. The safety instructions are formulated according to the strict testing of the factory, and the design and specifications of the equipment are subject to change without prior notice. For latest product information, please check the GODOX website and view latest electronic instruction.
22. Some products have built-in lithium batteries. Please use specified chargers, and use them within a proper range of the specified voltage and temperature according to the correct operating instructions.
23. Some products are battery powered. Do not use any batteries, power sources or accessories not specified in the instructions for such products. Keep batteries and other accessories out of the reach of children and infants. In the instance that a child or infant swallows a battery or accessory, immediate emergency medical attention is required. If the battery leaks, becomes discolored, deformed, emits smoke, or emits an abnormal odor, remove it immediately. Be careful during removal to avoid burns. Continued use could result in fire, electric shock, or burns. Do not use any deformed or modified batteries. Do not disassemble or modify this product or battery. Do not heat or solder the battery. Keep the battery away from fire or water. Do not incorrectly insert the positive and negative ends of batteries, or mix old and new batteries or batteries of different types together.
24. One-year warranty period, accessories such as consumable batteries, adapters, power cords, etc. are not covered by this warranty.

25. If it is found that the equipment is repaired without authorization, the one-year warranty period will be cancelled and relevant fees will be charged for maintenance.
26. Machine failures caused by non-standard operation are not covered by the warranty.

keep these instructions!

Foreword

Thank you for purchasing!

Powered by AC/DC power source, KNOWLED RGBWW creative bulb C7R is featured with built-in lithium battery, adjustable brightness, color temperature and HSI. It can achieve RGBWW mode, HSI mode, GEL mode and 14 FX modes when collocating with "Godox light" APP.

⚠ Warning

- ⚠ Do not disassemble. Should repairs become necessary, this product must be sent to an authorized maintenance center.
- ⚠ Always keep this product dry. Do not use in rain or in damp conditions.
- ⚠ Please shut off the power source when not in use.
- ⚠ The light body shell will be hot after long time use, do not touch.

FCC Statement

This device complies with part 15 of the FCC Rules. Operation is subject to the following two conditions:

- (1) This device may not cause harmful interference, and
- (2) this device nt.

Note: This equipment has been tested and found to comply with the limits for a Class B digital device, pursuant to part 15 of the FCC Rules. These limits are designed to provide reasonable protection against harmful interference in a residential installation. This equipment generates uses and can radiate radio frequency energy and, if not installed and used in accordance with the instructions, may cause harmful interference to radio communications. However, there is no guarantee that interference will not occur in a particular installation. If this equipment does cause harmful interference to radio or television reception, which can be determined by turning the equipment off and on, the user is encouraged to try to correct the interference by one or more of the following measures:

- Reorient or relocate the receiving antenna.
- Increase the separation between the equipment and receiver.
- Connect the equipment into an outlet on a circuit different from that to which the receiver is connected.
- Consult the dealer or an experienced radio/TV technician for help.

The device has been evaluated to meet general RF exposure requirement.

The device can be used in portable exposure condition without restriction.

Name of Parts

Bulb

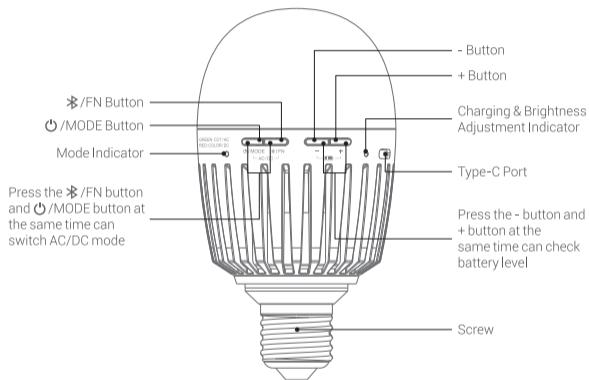

Charging Case

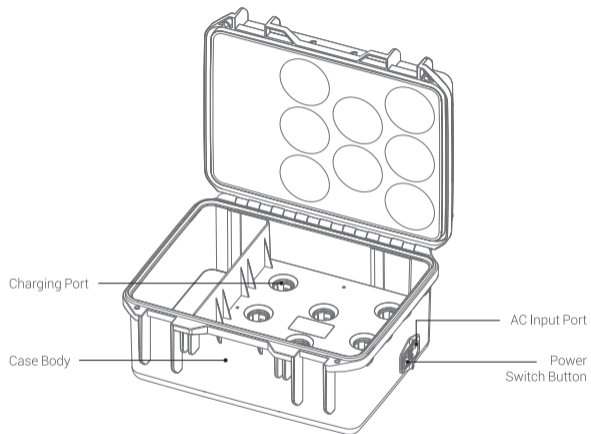

What's Inside



Light Body*1



Storage Bag*1



Type-C Power Cable*1



Instruction Manual*1

Item List for C7R-K8A/C7R-K8B

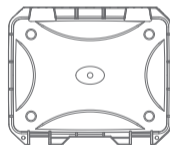

Charging Case*1



Bulb*8



Power Cable for Charging Case*1



Type-C Charging Cable*2



Storage Bag*2



Instruction Manual*1



Reflector*8

Note: C7R-K8A kit includes a charging case C7R-C8A and E26 screw bulbs, while C7R-K8B kit includes a charging case C7R-C8B and E27 screw bulbs.

The pictures are for reference only, products to prevail in kind.

AC Power Supply



screw holder
E26:100V~120V~50/60Hz 90mA
E27:200V~240V~50/60Hz 50mA

Lithium Battery Power Supply



7.6V 1300mAh

DC Power Supply

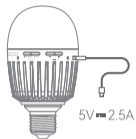

5V=2.5A

AC Mode/DC Mode

Long press the /MODE button and /FN button at the same time can switch power supply mode. The mode indicator flashes green three times means the bulb is in AC mode. It will not switch to battery power supply automatically once the AC power source is cut off. The mode indicator flashes red three times means the bulb is in DC mode. It will switch to battery power supply automatically once the DC power source is cut off.

Note: The bulb is AC mode by default.

Battery

Long press the + button and - button at the same time in power on status to check the battery level, the light body will flash.
The light body flashes green once means 1 grid of battery level.
The light body flashes green twice means 2 grid of battery level.
The light body flashes green three times means 3 grid of battery level.
The light body flashes red once means low battery level, please charge in time.

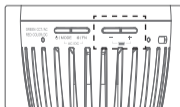

Power Switch

Long press the /MODE button for 2s to power on/off the device, after connected to power source.

Brightness Adjustment

Short press the - button or + button to switch the brightness among 10 levels from 0% to 100% with 10% of increment each step. Quick adjustment is available by long pressing the - button or + button. The brightness is also adjustable through "Godox Light" APP from 0% to 100%.

CCT Mode

Short press the /MODE button to CCT mode, the mode indicator will be constant on green. Short press the /FN button twice to adjust CCT among 6 levels in cycle: 2000K, 2700K, 3200K, 4300K, 5500K and 6500K. Short press the /FN button quickly can return to the previous menu. The CCT (2000K~10000K) and GM (-50~+50) are also adjustable through "Godox Light" APP.

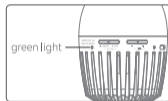

HSI Mode

Short press the /MODE button to HSI mode, the mode indicator will be constant on red. Short press /FN button to switch among the following 9 colors in cycle: red, green, blue, cyan, magenta, yellow, pink, violet and orange. Short press /FN button quickly twice can return to the previous menu. The RGBW mode, HSI mode, GEL mode, FX mode and color picker are also available through "Godox Light" APP.

Note: The default saturation of HSI is 100% in light body control.

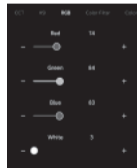

Bluetooth Setting

Bluetooth reset: Long press the ***/FN** button until it flashes blue three times, it will return to the previous effect after successfully reset.

APP download: Scan the QR code to download "Godox Light" APP (both Android and iOS systems are available).

Note: the APP can be used directly on the firstly installed device (smartphone or tablet). When changing to other mobile device, the light shall be reset before the normal usage of APP. The Bluetooth is on by default.



Overheating Protection

The working environment temperature of C7R is -10°C to 40°C, it is recommended to keep the environment temperature below 40°C to avoid any overheating problems. If the bulb enters "battery protection mode", it will resume normal operation after the internal temperature has cooled down.

Technical Data

Model	C7R
Input Power	Max.10W
Lithium Battery Parameters	7.6V/1300mAh
Lithium Battery Charging Time	approx 2h 30min (AC 220V) approx 3h (DC 5V 3A)
Lithium Battery Working Time	approx 1h
DC Input	5V 2.5A
AC Input	100V-120V~50/60Hz 90mA/200V-240V~50/60Hz 50mA
Compatible Bulb Holder	E26/E27
CCT (adjustable on APP)	2000K-10000K
Brightness (adjustable on APP)	0%-100%
Average TLCI	≥97
Average CRI	≥96
Illuminance Data(100% brightness & 5500K CCT)	≈360Lux/34fc(1.64ft/0.5m)
	≈101Lux/9fc(3.28ft/1m)
Controlling Method	Bluetooth APP control/light body control
Bluetooth Controlling Distance	Max. 30m
Working Environment Temperature	-10°C~ + 40°C
Dimension	73mm*73mm*136mm
Net Weight	256g

Specifications and data may subject to changes without notice.

Technical Data of the Charging Case (sold separately)

Model	C7R-C8A	C7R-C8B
Charging Port	E26 Screw	E27 Screw
Dimension	302mm*360mm*194mm/11.9"*14.2"*7.64"	302mm*360mm*194mm/11.9"*14.2"*7.64"
Net Weight ≈	2.7kg	2.7kg

Warning

Operating frequency:2402MHz – 2480MHz
Maximum EIRP Power: 5dBm

Declaration of Conformity

GODOX Photo Equipment Co.,Ltd. hereby declares that this equipment are in compliance with the essential requirements and other relevant provisions of Directive 2014/53/EU. In accordance with Article 10(2) and Article 10(10), this product is allowed to be used in all EU member states. For more information of DoC, Please click this web link:

<https://www.godox.com/eu-declaration-of-conformity>

The device complies with RF specifications when the device used at 0mm from your body.



Dimming not allowed

"For lamps with a weight significantly higher than that of the lamps for which they are a replacement, attention should be drawn to the fact that the increased weight may reduce the mechanical stability of certain luminaires and lampholders and may impair contact making and lamp retention."